

Article number: 3901210007200

Description: Worm gear with solid input shaft
VF 210A-7-HS

Measures

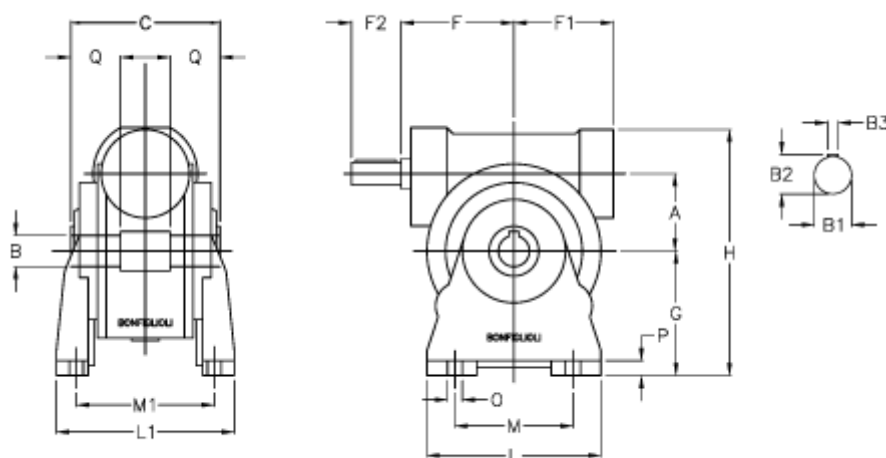

a	= 210.0	F1 = 277	P = 25
B	= 90	g = 335	Q = 85.0
B1 E7	= 48	H = 665	
B2	= 51.5	L = 440	
B3 H9	= 14	L1 = 320	
C	= 260	m = 340	
Description = VF 210A-xx-HS		M1 = 265.0	
F	= 230.0	O = 26.0	